

AC1025 • 25 Amp Current Transformer

Low Cost 50/60Hz Current Transformers

Applications

- Sensing Overload Current
- Ground fault detection
- Metering
- Analog to Digital Circuits

Electrical Specifications @ 20°C ambient

Electrical Specifications	
Primary Current	25A nom., 75A max.
Turns Ratio	1000:1 nominal
Volt per Amp Ratio at 25A for 100 ohm load	0.100 V/A
Volt per Amp Ratio at 2.5A for 100 ohm load	0.098 V/A
DC Resistance at 20°C	48 ohms
Dielectric Withstanding Voltage (Hi-pot)	4KVrms
Mechanical Specifications	
Case	Polycarbonate
Encapsulant	Epoxy
Flammibility	Conforms to UL94-VO
Terminals	Pins Ø 1.0mm
Marking	Date Code (W/Y) AC1025, Dot at start pin
Approximate Weight	35.5 grams
Tolerance	±0.2mm



Environmental Specifications

Storage Temperature	-55° to +130°C
Insulation Resistance	100 megohms min.

Output Volts vs Input Current
For various ohmic loads

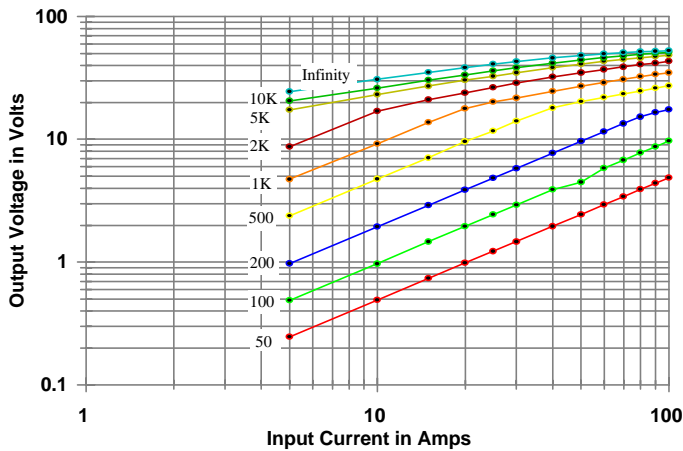

%RE vs RL at Rated primary current
(AC1025)

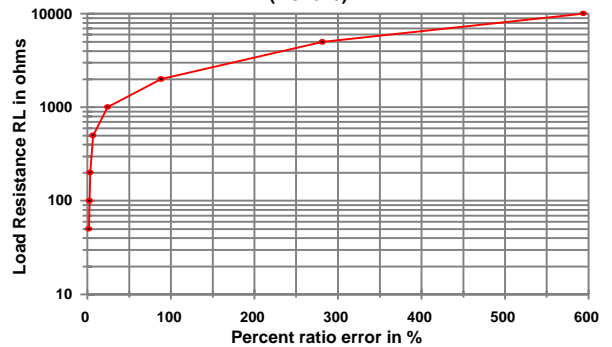

Typical Excitation Curve
(AC1025~AC1030)

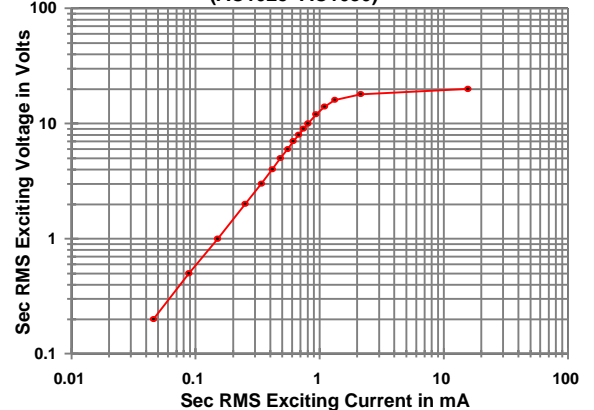

Dimensions

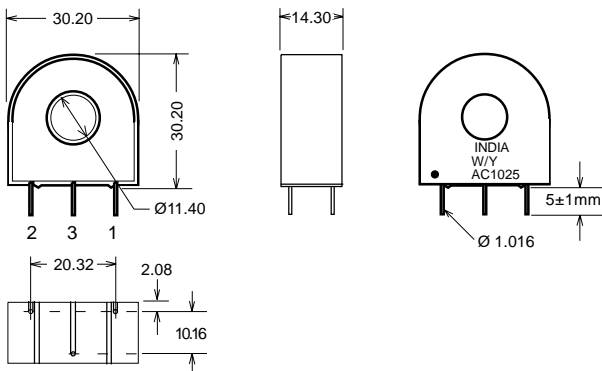

Notes:

- 1) Unless requested, the terminating resistor and the one-turn primary are not supplied
- 2) Pin 3: Normally for mechanical support only but will be used on center tapped designs

